

THULE[®]
SWEDEN

➤ Instructions

Thule Yepp Nexxt Maxi Rack Mount

12080211, 12080212, 12080213, 12080214,
12080215, 12080216



EN Child bike seat
DE Fahrradkindersitz
FR Siège vélo enfant
NL Fietszitje
IT Seggiolino da bici
ES Portabebés bici
PT Cadeira de criança para bicicleta
SV Cykelbarnstol
DK Cykelstol
NO Barnesete til sykkel
FI Polkupyörän lastenistuin
ET Jalgratta lasteiste
LV Velosipēda bērnu sēdekļis
LT Dviračio kėdutė vaikams
PL Fotelik rowerowy
RU Детское велосипедное сиденье
UK Дитяче велосипедне крісло
BG Детско столче за велосипед
CS Dětská cyklosedačka
SK Detská cyklosedačka
SL Otroški kolesarski sedež

HR/BIH Dječja sjedalica za bicikl
RO Scaun de copii pentru bicicletă
HU Kerékpáros gyerekülés
EL Παιδικό κάθισμα ποδηλάτου
TR Çocuk bisiklet koltuğu

HE כיסא אופניים לילד
AR مقعد دراجة الطفل

ZH 儿童自行车座椅
JA お子様用サイクルシート
KO 어린이 자전거 시트
TH เก้าอี้เด็กสำหรับจักรยาน



ASTM F1625

EN 14344:2004

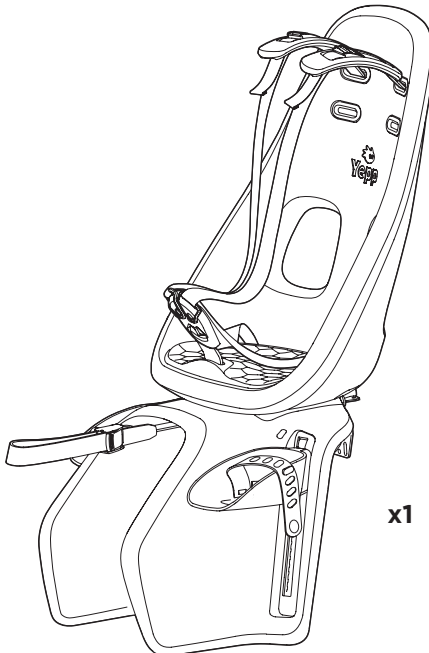
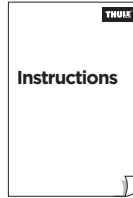

x1



x1



FIT

Europe & rest of the world	USA & Canada
9-72 M 9-22 kg 20-48,5 lbs	9-72 M 9-18 kg 20-40 lbs



i



Your Key-Number

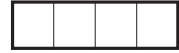

NO FIT



0-9 M

Min. load capacity: 25 kg / 55 lbs

Must comply to ISO11243

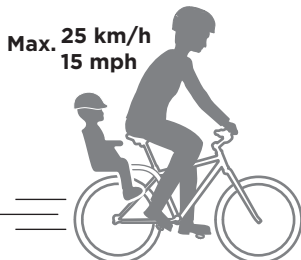
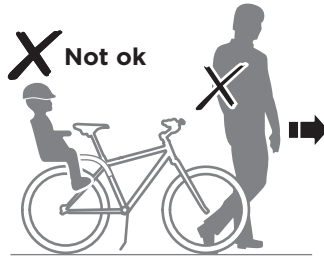
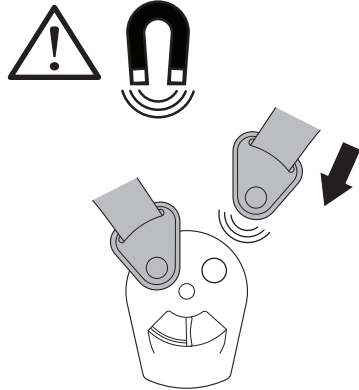
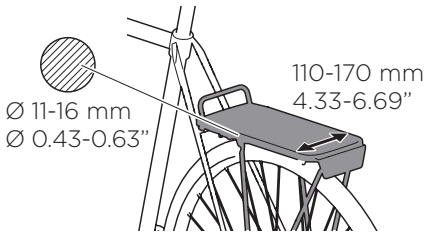

1

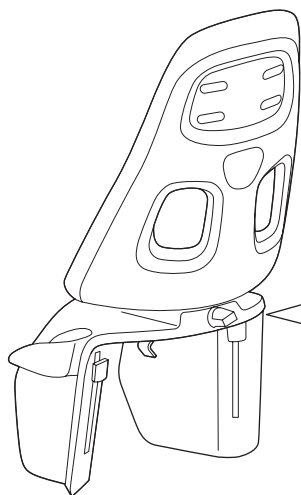

A

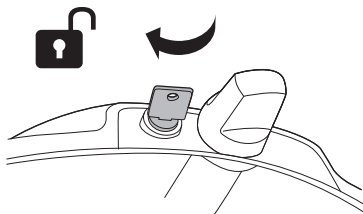

B

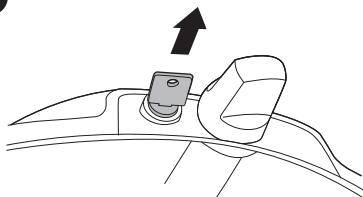

C

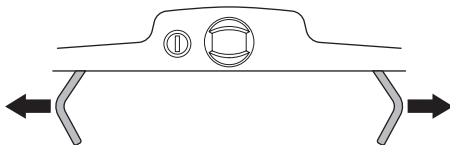
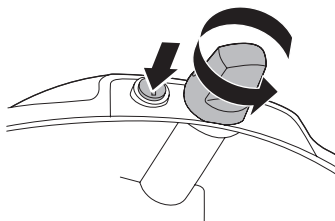

2

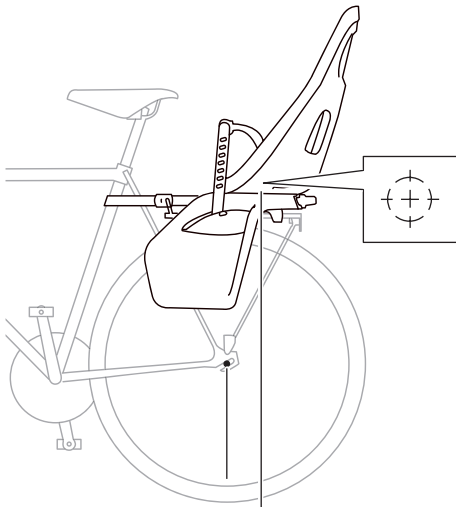
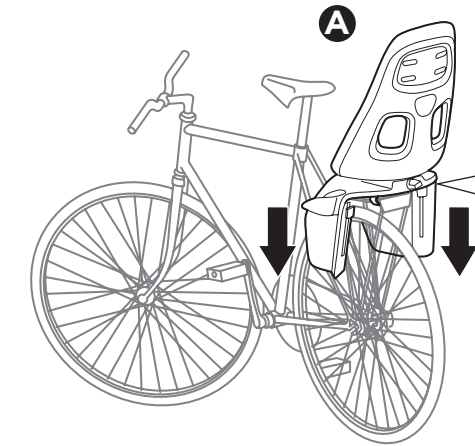

→
*** max 100 mm**
max (3.94")

B

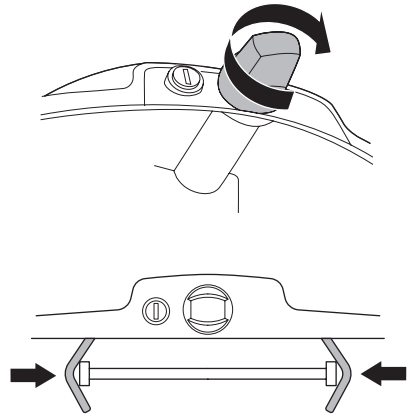

C

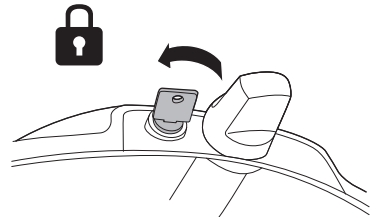

D

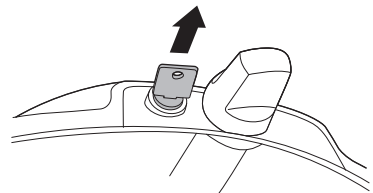

* **DE** max 0 mm

4

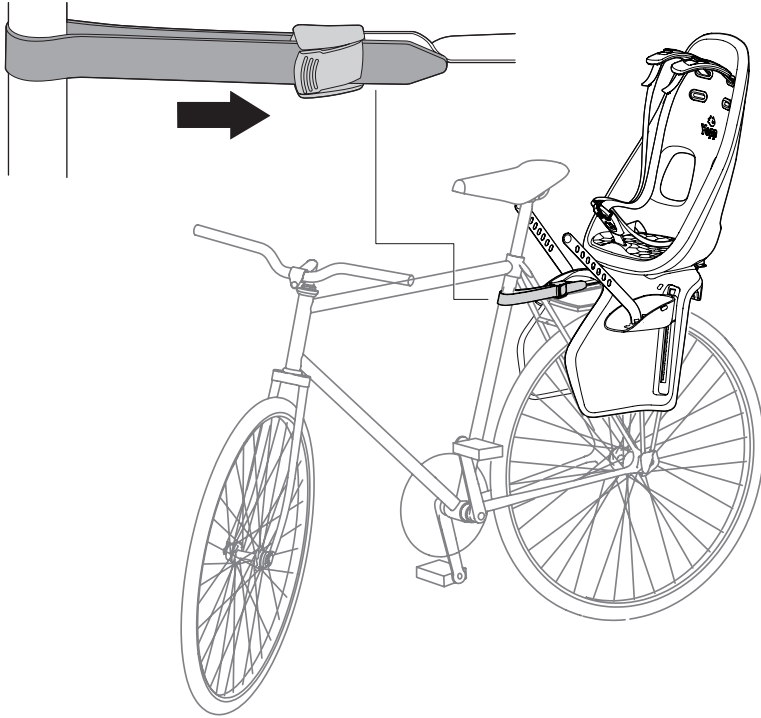

5

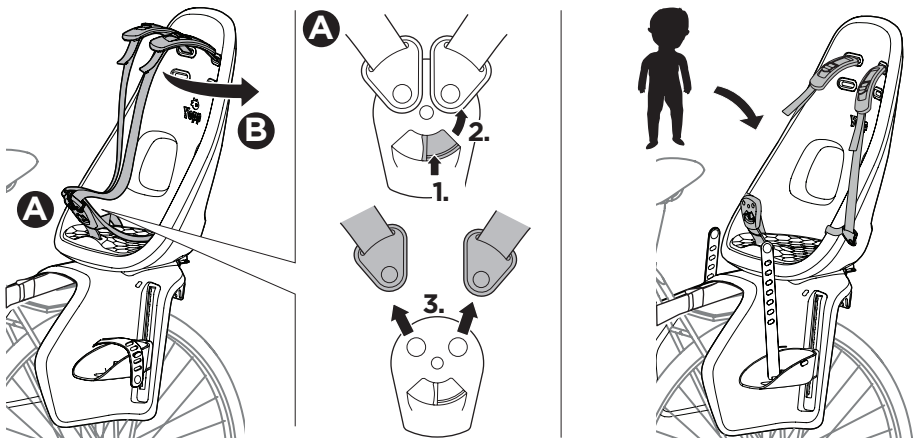

6

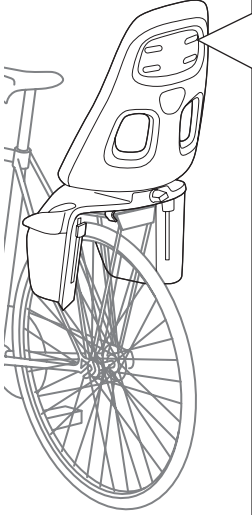

A

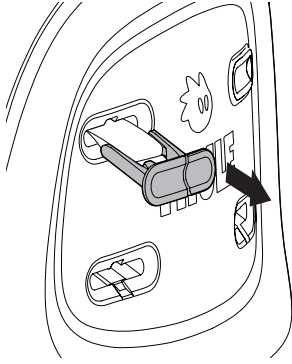

B

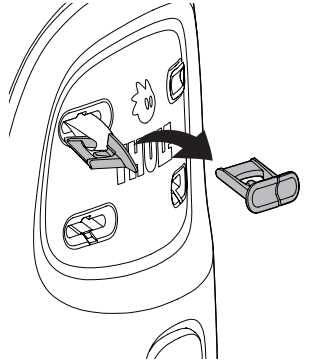

C

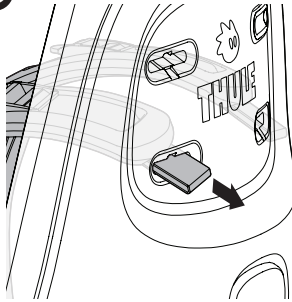

D

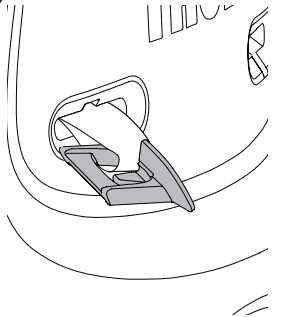

E

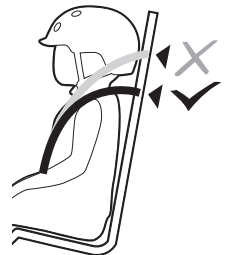
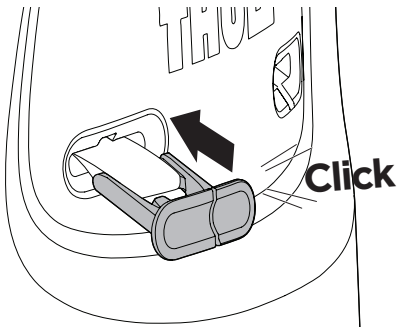

7

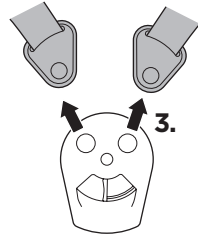
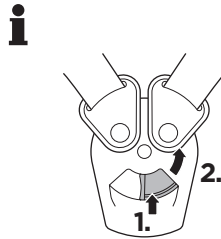
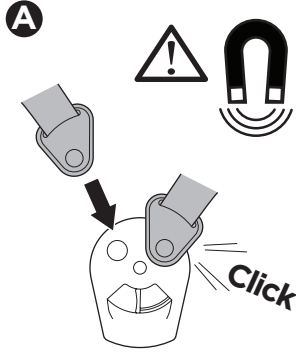

8

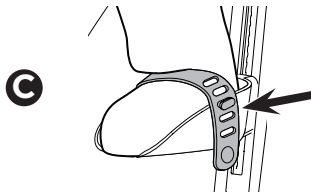
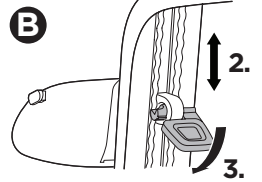
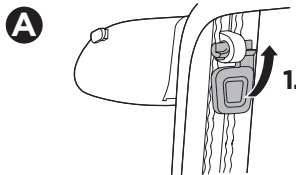

Thule One-Key System

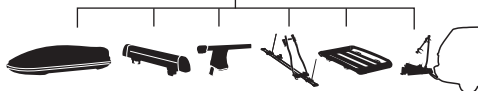

450400 (x4)

450600 (x6)

450800 (x8)

451200 (x12)